



# USER GUIDE

Solar Inverter

WVLVS-IP55-6KW

*Solar Inverter*

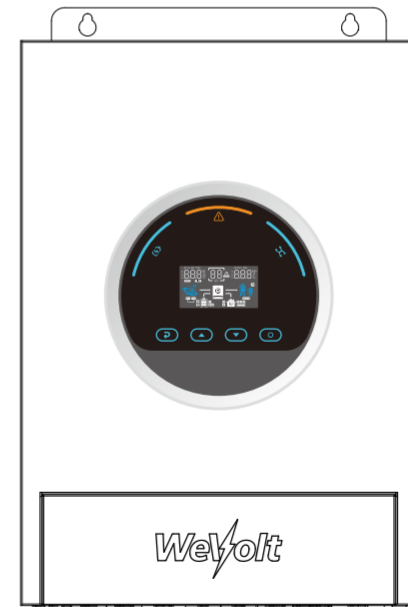

## Contents

<b>ABOUT THIS MANUAL</b> .....	<b>01</b>
Purpose .....	01
Scope .....	01
Safety instructions .....	01
<b>WARNING MARKS</b> .....	<b>02</b>
<b>INTRODUCTION</b> .....	<b>03</b>
Features .....	03
Basic system architecture .....	03
<b>PRODUCT OVERVIEW</b> .....	<b>04</b>
<b>SPECIFICATIONS</b> .....	<b>06</b>
<b>INSTALLATION</b> .....	<b>09</b>
Safety guidance .....	09
Unpacking and inspection .....	09
Preparation .....	10
Mounting the unit .....	10
Battery connection .....	11
AC input/output connection .....	12
PV connection .....	14
DRY and CT Contact Signal .....	15
Meter Communication .....	15
Wiring System for Inverter .....	16
Wiring System for dual output .....	17
<b>OPERATION</b> .....	<b>18</b>
Power on/off .....	18
Operation and display panel .....	18
LCD display icons .....	19
LCD operation flow chart .....	21
Base information page .....	21
Setting page .....	24
Energy stored data page .....	31
BMS information page .....	31
Rated information page .....	32
Lithium battery communication .....	33
<b>PARALLEL INSTALLATION GUIDE</b> .....	<b>34</b>
Introduction .....	34
Mounting the unit .....	34
Package contents .....	35
Wiring connection .....	35
LCD setting and display .....	40
Commissioning .....	40
<b>WARNING CODE TABLE</b> .....	<b>42</b>
<b>FAULT CODE TABLE</b> .....	<b>42</b>

## ABOUT THIS MANUAL

### Purpose

This manual describes the assembly, installation, operation, warning code and fault code of this unit. Please read this manual carefully before installations and operations. Keep this manual for future reference.

### Scope

This manual provides safety and installation guidelines as well as information on tools and wiring.









### Safety Instructions

 **WARNING: This chapter contains important safety and operating instructions. Read and keep this manual for future reference.**

1. Before using the unit, read all instructions and cautionary markings on the unit, the batteries and all appropriate sections of this manual.
2. **CAUTION** To reduce risk of injury, charge only deep-cycle lead acid type rechargeable batteries. Other types of batteries may burst, causing personal injury and damage.
3. Do not disassemble the unit. Take it to a qualified service center when service or repair is required. Incorrect re-assembly may result in a risk of electric shock or fire.
4. To reduce risk of electric shock, disconnect all wirings before attempting any maintenance or cleaning. Turning off the unit will not reduce this risk.
5. **CAUTION** Only qualified personnel can install this device with battery.
6. **NEVER** charge a frozen battery.
7. For optimum operation of this inverter/charger, please follow required spec to select appropriate cable size. It's very important to correctly operate this inverter/charger.
8. Be very cautious when working with metal tools on or around batteries. A potential risk exists to drop a tool to spark or short circuit batteries or other electrical parts and could cause an explosion.
9. Please strictly follow installation procedure when you want to disconnect AC or DC terminals. Please refer to INSTALLATION section of this manual for the details.
10. Fuse is provided as over-current protection for the battery supply.
11. **GROUNDING INSTRUCTIONS** This inverter/charger should be connected to a permanent grounded wiring system. Be sure to comply with local requirements and regulation to install this inverter.
12. **NEVER** cause AC output and DC input short circuited. Do NOT connect to the mains when DC input short circuits.
13. **WARNING!!** Only qualified service persons are able to service this device. If errors still persist after following troubleshooting table, please send this inverter/charger back to local dealer or service center for maintenance.
14. **WARNING!!** This series of off-grid inverters provides a backfeed function without grid-tie protection. If enabled, implement protective measures prior to operation. The customer assumes full liability for any accidents resulting from the use of this function.

## WARNING MARKS

Warning marks inform users of conditions which can cause serious physical injury or death, or damage to the device. They also tell users how to prevent the dangers. The warning marks used in this operation manual are shown below:

Mark	Name	Instruction	Abbreviation	
	Danger	Danger	Serious physical injury or even death may occur if not follow relevant requirements.	
	Warning	Warning	Physical injury or damage to the device may occur if not follow relevant requirements.	
	Forbid	Electrostatic sensitive	Damage may occur if relevant requirements are not followed.	
	Hot	High temperature	Do not touch the base of the inverter as it will become hot.	
	Note	Note	The procedures taken for ensuring proper operation.	Note

## INTRODUCTION

This is a multi-function inverter/charger, combining functions of inverter, MPPT solar charger and battery charger to offer uninterruptible power support with portable size. It's comprehensive LCD display offers user-configurable and easy-accessible button operation such as battery charging current, AC/solar charger priority, and acceptable input voltage based on different applications.

### Features

- Pure sine wave inverter
- Built-in MPPT solar charge controller
- Configurable input voltage range for home appliances and personal computers via LCD setting
- Configurable battery charging current based on applications via LCD setting
- Configurable AC/Solar Charger priority via LCD setting
- Compatible to mains voltage or generator power
- Auto restart while AC is recovering
- Overload/Over temperature/short circuit protection
- Inverter running without battery
- Lithium battery activation function
- Cold start function
- Parallel Mode: A single-phase system supports a maximum of 12 units; a three-phase system supports a maximum of 12 units, with at least 1 unit per phase (battery connection is required).
- Intelligent fan control greatly reduces fan noise
- Dual output load function

### Basic System Architecture

The following illustration shows basic application for this inverter/charger. It also includes following devices to have a complete running system:

- Generator or Utility
- PV modules (option)
- Meter/CT (option)

Consult with your system integrator for other possible system architectures depending on your requirements.

This inverter can power all kinds of appliances in home or office environment, including motor-type appliances such as tube light, fan, refrigerator and air conditioner.

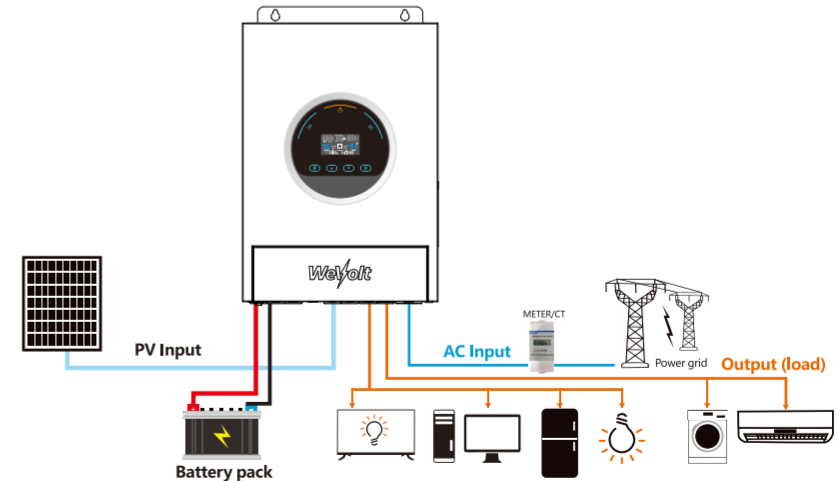

**NOTE:** The inverter must be connected to CT or meter to enable Anti-backflow function. Otherwise, the feed power cannot be controlled. (Only CT with a ratio of 1:1000 is supported)

## PRODUCT OVERVIEW

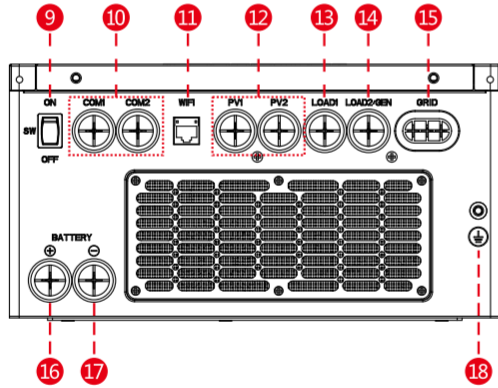
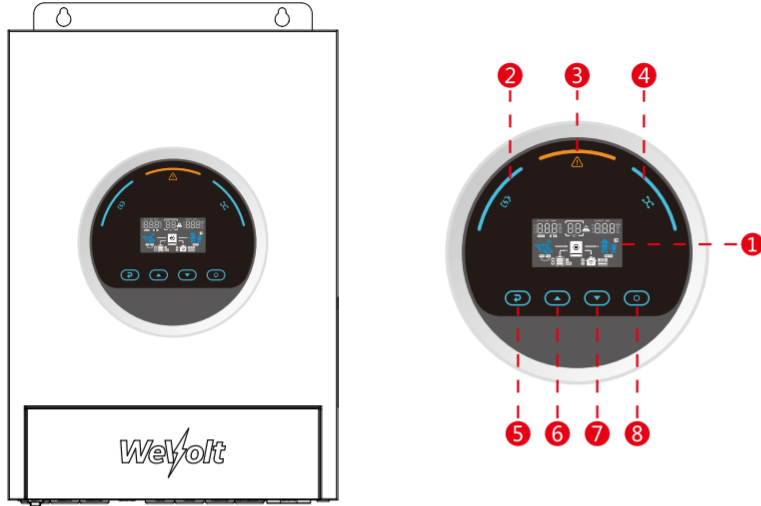

- |                                      |  |
|--------------------------------------|--|
| 1. LCD display                       | 10. Communication connection port*         |
| 2. Charging indicator                | 11. WiFi connection port                   |
| 3. Fault or warning indicator        | 12. PV input connection port               |
| 4. Utility bypass/Inverter indicator | 13. Load1 output port                      |
| 5. ESC button                        | 14. Load2 output port/Generator input port |
| 6. UP button                         | 15. Grid input port                        |
| 7. Down button                       | 16. Battery+ connection port               |
| 8. Enter button                      | 17. Battery- connection port               |
| 9. Switch                            | 18. Ground wire port*                      |

### 10 Definition communication port pin

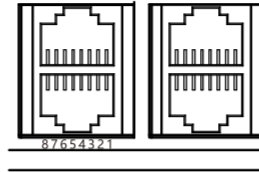

METER	BMS-485
RS232	BMS-CAN

NO.	BMS-485	BMS-CAN	RS-232	METER
1	RS485-B	NC	RS232-TXD	RS485-B
2	RS485-A	NC	RS232-RXD	RS485-A
3	VSS	VSS	VDD	VSS
4	NC	CAN.H	VSS	NC
5	NC	CAN.L	NC	NC
6	VSS	VSS	NC	VSS
7	RS485-A	NC	NC	RS485-A
8	RS485-B	NC	VSS	RS485-B

**NOTE:** The inverter must be connected to CT or meter to enable Anti-backflow function. Otherwise, the feed power cannot be controlled. (Only CT with a ratio of 1:1000 is supported)

### 18 The earth terminal shall be connected. Select the 32 options in compliance with applicable local regulations.

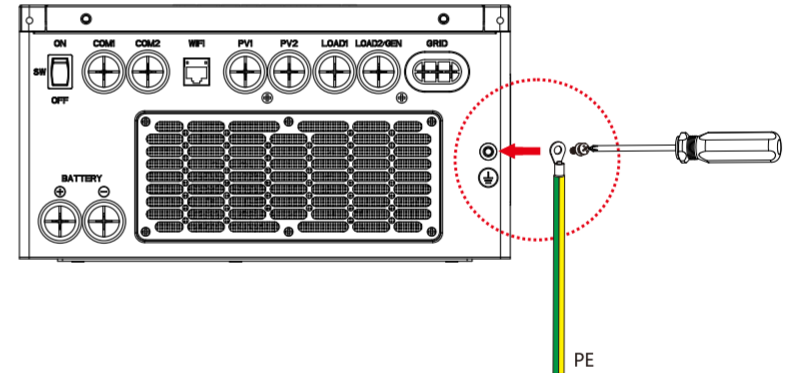

## SPECIFICATIONS

Line mode specifications	
Model	WVLVS-IP55-6KW
Rated output power	6000VA
	6000W
Nominal DC input voltage	48V
Input voltage waveform	Sinusoidal (utility or generator)
Nominal input voltage	230Vac
Low line voltage disconnect	90Vac±3V(For Home Appliances)170Vac±3V(For Computers)
Low loss voltage re-connect	100Vac±3V(For Home Appliances)180Vac±3V(For Computers)
High line voltage disconnect	280Vac±3V
High line voltage re-connect	270Vac±3V
Max AC input voltage	280Vac±3V
Nominal input frequency	50Hz/60Hz(Auto detection)
Low line frequency disconnect	40±0.2Hz
Low line frequency re-connect	42±0.2Hz
High line frequency disconnect	65±0.2Hz
High line frequency re-connect	63±0.2Hz
Output voltage waveform	As same as input waveform
Output short circuit protection	Line mode: Circuit Breaker; Battery mode: Electronic Circuits
Efficiency (Line mode)	>95%(Rated R load, battery full charged)
Transfer time (Single unit)	10ms typical (UPS); 20ms typical (Appliances)
Transfer time (Parallel)	50ms typical
Pass through without battery	Yes
Max. Bypass overload current	40A
Max. Bypass input current	50A
Max. Inverter/Rectifier current	27.3A/6000W

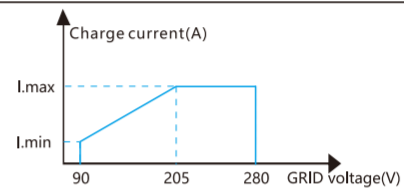
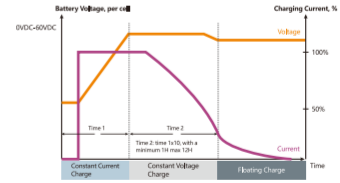

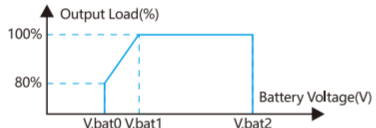
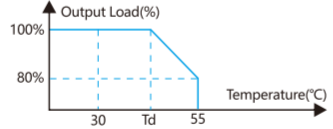





Utility charge mode specifications			
Model	WVLVS-IP55-6KW		
Nominal input voltage	230Vac		
Input voltage range	90-280Vac		
Nominal output voltage	Dependent on battery type		
Max. Grid charge current	120A		
Charge current regulation	5A-120A(Adjustable unit is 1A)		
Over charge protection	Yes		
Grid charging current (I.max/I.min)	 <p>Relationship between battery charging current and grid voltage.</p> <p>120A/40A</p>		
Solar charging & Grid charging			
Max. PV Open Circuit Voltage	500V		
PV voltage range	85V-450V		
Max. Input power	12000W		
Max. Solar charging current	120A		
Max. Charging current(PV+Grid)	120A		
Max. Input current	18A+18A (ISC22A+22A)		
Min. Startup voltage	75V		
Charge algorithm			
Algorithm	Three stage: Boost CC (Constant current stage)-> Boost CV(Constant voltage stage)-> Float FV(Constant voltage stage)		
Charging curve			
Battery type setting	Battery Type	Boost CC/CV	Float
	AGM	56.4V	54V
	Flooded	58.4V	54V
	Self-defined Lithium	Adjustable, up to 60V	

Inverter mode specifications	
Model	WVLVS-IP55-6KW
Rated output power	6000VA
	6000W
Nominal DC input voltage	48V
Output voltage waveform	Pure sine wave
Nominal output voltage	230Vac±5%
Nominal output frequency(Hz)	50±0.2Hz/60±0.2Hz(Adjustable)
Parallel capability	Yes, single phase up to 12 units, three phase up to 12 units
Peak efficiency	93%
Over-Load protection(SMPS load)	5s@ ≥ 150%load; 10s@ 105%~150%load
Surge rating	2* rated power for 5s
Capable of starting electric	Yes
Output short circuit protection	Yes
Cold start voltage	46V
Low DC input shut-down Load < 50% @Load ≥ 50%	43V
	42V
High DC input alarm & fault	62V±0.4V
High DC input recovery	60V±0.4V
Battery voltage Limitation (V.bat0/V.bat1/V.bat2)  When battery voltage is lower than "V.bat1", output power will be derated. The minimum AC output voltage is 180V.	
	42V/50V/62V
Temperature limitation(Td)  When ambient temperature is higher than 40°C/45°C, output power will be derated. The minimum Ac output voltage is 180V.	
	45°C
General specifications	
Operating temperature	-10C°~55C°
Range storage temperature	-15C°~60C°
Net weight(kg)	12.3kg
Gross weight(kg)	14.2kg
Product size(D*W*H)	430x302x156mm
Package dimension(D*W*H)	515x390x255mm

## INSTALLATION

### Safety Guidance

Warning marks inform users of conditions which can cause serious physical injury or death, or damage to the device. They also tell users how to prevent the dangers. The warning marks used in this operation manual are shown below:

	<ul style="list-style-type: none"> <li>After receiving this product, first confirm the product package is intact. If any question, contact the logistic company or local distributor immediately.</li> <li>The installation and operation of inverter must be carried out by professional technicians who have received professional training and thoroughly familiar with all the contents in this manual and the safety requirements of the electrical system.</li> </ul>
	<ul style="list-style-type: none"> <li>Do not carry out connection/disconnection, unpacking inspection and unit replacement operations on the inverter when power source is applied. Before wiring and inspection, users must confirm the breakers on DC and AC side of inverter are disconnected and wait for at least 5 minutes.</li> </ul>
	<ul style="list-style-type: none"> <li>Ensure there is no strong electromagnetic interference caused by other electronic or electrical devices around the installation site.</li> <li>Do not refit the inverter unless authorized.</li> <li>All the electrical installation must conform to local and national electrical standards.</li> </ul>
	<ul style="list-style-type: none"> <li>Do not touch the housing of the inverter or the radiator to avoid scald as they may become hot during operation.</li> </ul>
	<ul style="list-style-type: none"> <li>Ground properly before operation.</li> </ul>
	<ul style="list-style-type: none"> <li>Do not open the surface cover of the inverter unless authorized. The electronic components inside the inverter are electrostatic sensitive. Do take proper anti-electrostatic measures during authorized operation.</li> </ul>
	<ul style="list-style-type: none"> <li>The inverter needs to be reliably grounded.</li> </ul>
	<ul style="list-style-type: none"> <li>Ensure that DC and AC side circuit breakers have been disconnected and wait at least 5 minutes before wiring and checking.</li> </ul>

### Unpacking and Inspection

Before installation, please inspect the unit. Be sure that nothing inside the package is damaged. You should have received the following items inside of package:

 Inverter unit x 1	 Manual x 1	 WiFi module x 1 *	 Parallel communication cable x 1	 Parallel communication terminal connector x 1
 O-shaped terminal x 2	 Expansion bolt x 2	 Wall Hangers x 1 and Screws x 3	 Battery input screw x 2	 Case grounding screw x 1

\* Note: WIFI module is optional.

## Preparation

Before connecting all wirings, please take off bottom cover by removing two screws as shown below.

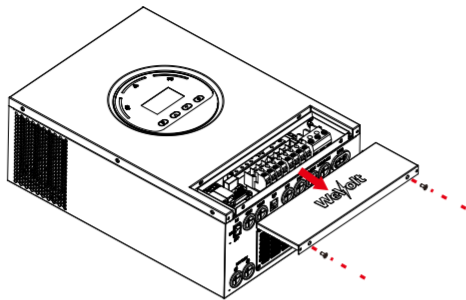

## Mounting the Unit

Consider the following points before selecting where to install:

- Do not mount the inverter on flammable construction materials.
- Mount on a solid surface.
- Install this inverter at eye level in order to allow the LCD display to be read all the time.
- The ambient temperature should be between -10°C and 55°C to ensure optimal operation.
- The recommended installation position is to be mounted on the wall vertically.
- Be sure to keep other objects and surfaces as shown in the right diagram to guarantee sufficient heat dissipation and to have enough space for removing wires.

### Installation Steps:

1. Install the bracket with M4 screw to connect the bracket with the inverter;
2. Then install the inverter on the wall with M6 expansion screw, and leave a distance of 60cm between the inverters, as shown in the figure:

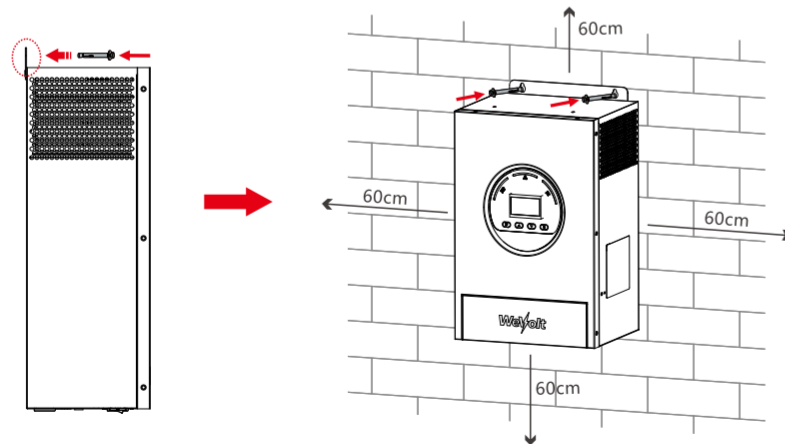

 **SUITABLE FOR MOUNTING ON CONCRETE OR OTHER NON-COMBUSTIBLE SURFACE ONLY.**

## Battery Connection

**CAUTION:** For safety operation and regulation compliance, it's requested to install a separate DC over-current protector or disconnect device between battery and inverter. It may not be requested to have a disconnect device in some applications, however, it's still requested to have over-current protection installed. Please refer to typical amperage in below table as required fuse or breaker size.

**WARNING!** All wiring must be performed by a qualified personnel.

**WARNING!** It's very important for system safety and efficient operation to use appropriate cable for battery connection. To reduce risk of injury, please use the proper recommended cable and terminal size as below.

Model	Gauge	Cable(mm <sup>2</sup> )	Torque Value
6KVA	3AWG	36	2 Nm

### Please follow below steps to implement battery connection:

1. Assemble battery ring terminal based on recommended battery cable and terminal size.
2. Connect all battery packs as units requires. It's suggested to connect at least 200Ah capacity battery.
3. Insert the ring terminal of battery cable flatly into battery connector of inverter and make sure the bolts are tightened with torque of 2 Nm. Make sure polarity at both the battery and the inverter/charge is correctly connected and ring terminals are tightly screwed to the battery terminals.

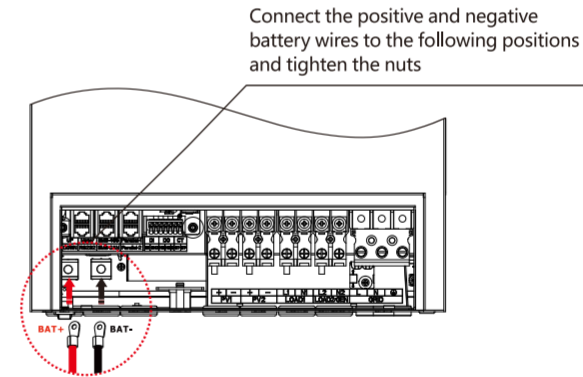

**WARNING: Shock hazard**

Installation must be performed with care due to high battery voltage in series.



**CAUTION!!** Do not place anything between the flat part of the inverter terminal and the ring terminal. Otherwise, overheating may occur.

**CAUTION!!** Do not apply anti-oxidant substance on the terminals before terminals are connected tightly.

**CAUTION!!** Before making the final DC connection or closing DC breaker/disconnector, be sure positive (+) must be connected to positive (+) and negative (-) must be connected to negative (-).

## AC Input/Output Connection

**CAUTION!!** Before connecting to AC input power source, please install a separate AC breaker, a self resetting overvoltage and undervoltage protector and a SPD (Surge Protection Device) between inverter and AC input power source. This will ensure the inverter can be securely disconnected during maintenance and fully protected from over current of AC input. The recommended spec of AC breaker is 50A for 6kVA.

**CAUTION!!** There are two terminal blocks with "IN" and "OUT" markings. Please do NOT mis-connect input and output connectors.  
**WARNING!** All wiring must be performed by qualified personnel.  
**WARNING!** It's very important for system safety and efficient operation to use appropriate cable for AC input connection. To reduce risk of injury, please use the proper recommended cable size as below.

### Suggested cable requirement for AC wires:

Model	Gauge	Cable (mm <sup>2</sup> )	Torque value
6KVA	6AWG	13	1.4~1.6 Nm

### Recommended circuit breaker type for Ac input:

Models	Maximum bypass	Recommended circuit breaker
6KVA	50A	2P-50A

### Please follow below steps to implement AC input/output connection:

1. Before making AC input/output connection, be sure to open DC protector or disconnecter firstly.
2. Remove insulation sleeve 10mm for three conductors. And shorten phase L and neutral conductor N by 3mm.

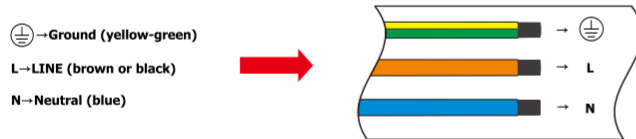

3. Insert AC input wires according to polarities indicated on terminal block and tighten the terminal screws. Be sure to connect PE protective conductor (⊕) firstly.

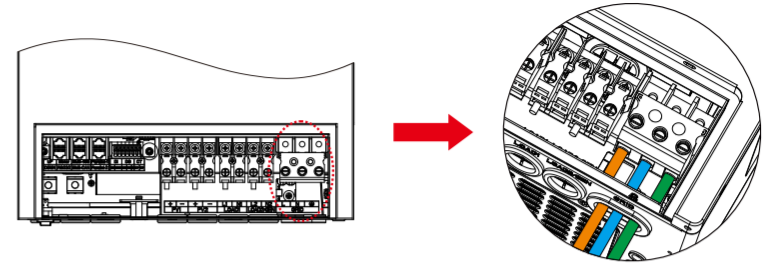

### WARNING:

Be sure that AC power source is disconnected before attempting to hardwire it to the unit.

4. Then, insert AC output wires according to polarities indicated on terminal block and tighten terminal screws. Be sure to connect PE protective conductor (⊕) firstly.

⊕ → Ground (yellow-green)  
 L1/L2 → Line (brown or black)  
 N1/N2 → Neutral (blue)

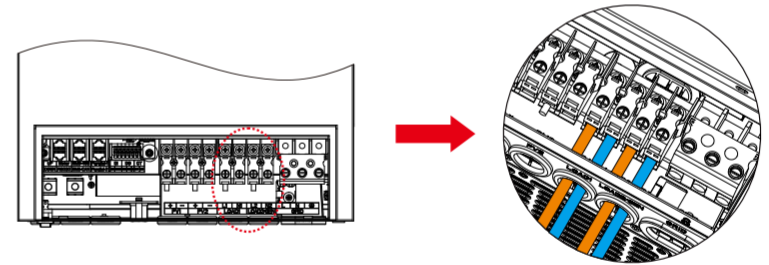
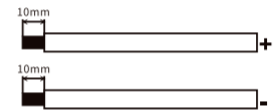

5. Make sure the wires are securely connected.

### CAUTION: Important

Be sure to connect AC wires with correct polarity. If L and N wires are connected reversely, it may cause utility short-circuited when these inverters are worked in parallel operation.

**CAUTION:** Appliances such as air conditioner are required at least 2~3 minutes to restart because it's required to have enough time to balance refrigerant gas inside of circuits. If a power shortage occurs and recovers in a short time, it will cause damage to your connected appliances. To prevent this kind of damage, please check manufacturer of air conditioner if it's equipped with time-delay function before installation. Otherwise, this inverter/charger will trigger overload fault and cut off output to protect your appliance but sometimes it still causes internal damage to the air conditioner.

## PV Connection



**CAUTION:** Before connecting to PV modules, please install separately a DC circuit breaker and a SPD (surge Protection Device) between inverter and PV modules.

**WARNING!** All wiring must be performed by qualified personnel.

**WARNING!** It's very important for system safety and efficient operation to use appropriate cable for PV module connection. To reduce risk of injury, please use the proper recommended cable size as below.

Model	Cable Size	Cable (mm <sup>2</sup> )	Torque
6KVA	10AWG	5	1.2Nm

## PV module selection:

When selecting proper PV modules, please be sure to consider below parameters:

1. Open circuit Voltage (Voc) of PV modules not exceeds max. PV array open circuit voltage of inverter.
2. Max. power voltage (Vmp) should be during PV array MPPT voltage range.

Solar charging mode	
Inverter model	6KVA
Max. PV array open circuit voltage	500V
PV array mppt voltage range	85Vdc~450Vdc

Please follow below steps to implement PV module connection:

1. Remove insulation sleeve 10mm for positive and negative conductors.

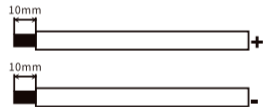

2. Check correct polarity of connection cable from PV modules and PV input connectors. Then, connect positive pole (+) of connection cable to positive pole (+) of PV input connector. Connect negative pole (-) of connection cable to negative pole (-) of PV input connector.

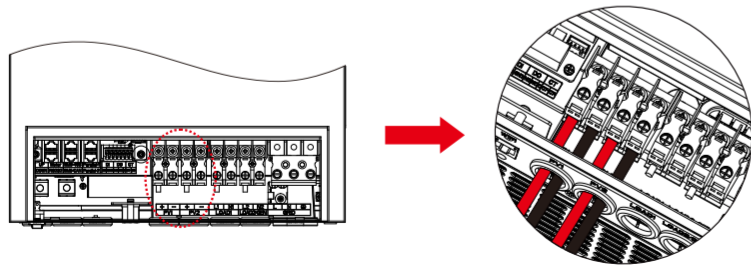

3. Make sure the wires are securely connected.

## DRY and CT Contact Signal (the CT is optional)

Unit status	Condition	Dry contact port:								
		DRY		CT						
DI	DO	CT	CT+	DI1	GND	NO	NC	C	CT-	CT+
Power off	Unit is off and no output is powered.	NO & C				NC & C				
Power on	Battery voltage < Setting value in Program 06	Open				Close				
	Battery voltage > Setting value in Program 07 or battery charging reaches floating stage	Close				Open				

## Meter Communication (the meter is optional)

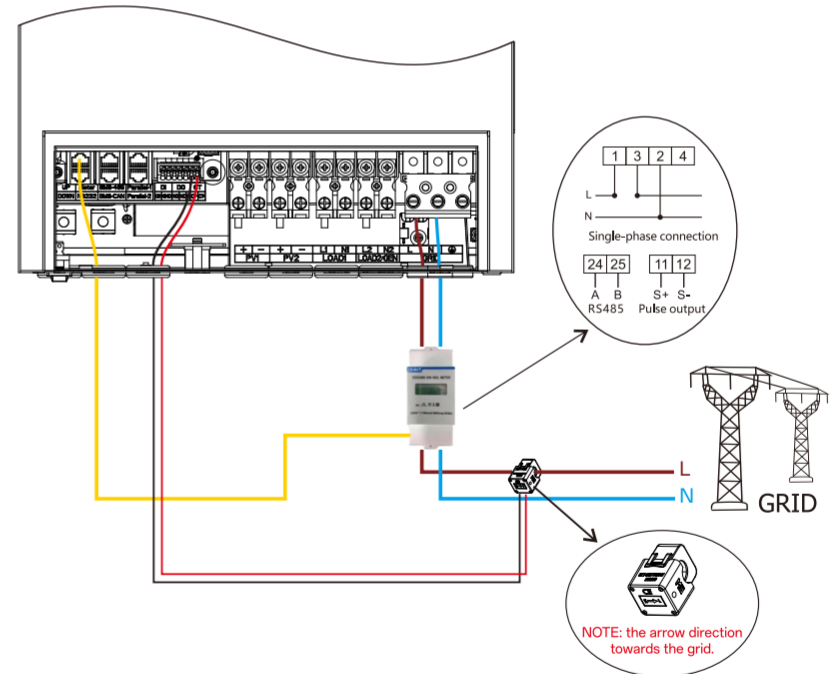

**NOTE:** 1. The inverter must be connected to CT or meter to enable anti-reflux function. Otherwise, the feed power cannot be controlled. (Only CT with a ratio of 1:1000 is supported)

2. Only one connection shall be selected: either the CT or the electricity meter. Both shall not be connected at the same time.

\*CT connection method (the CT is optional): Connect the white wire to CT+ and the black wire to CT-.

### Wiring System for Inverter

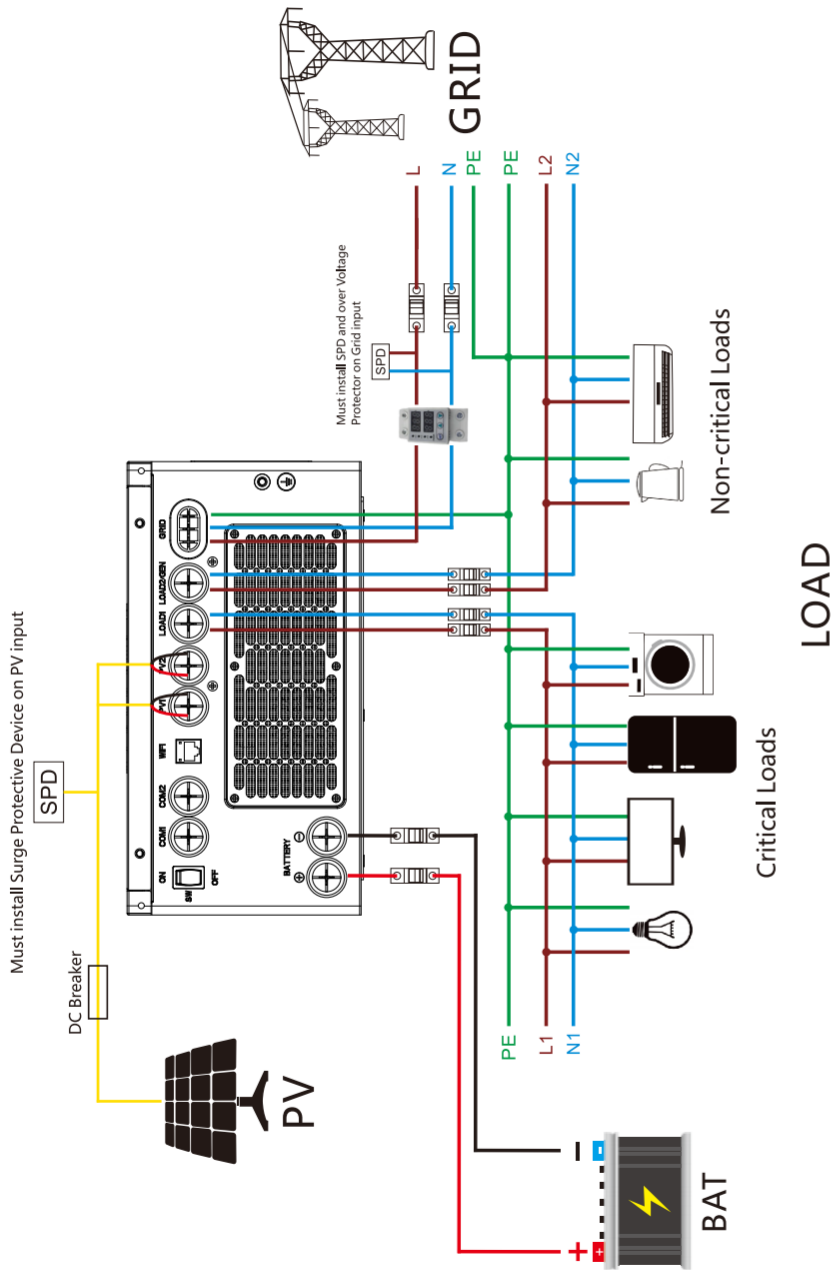

### Wiring System for dual output

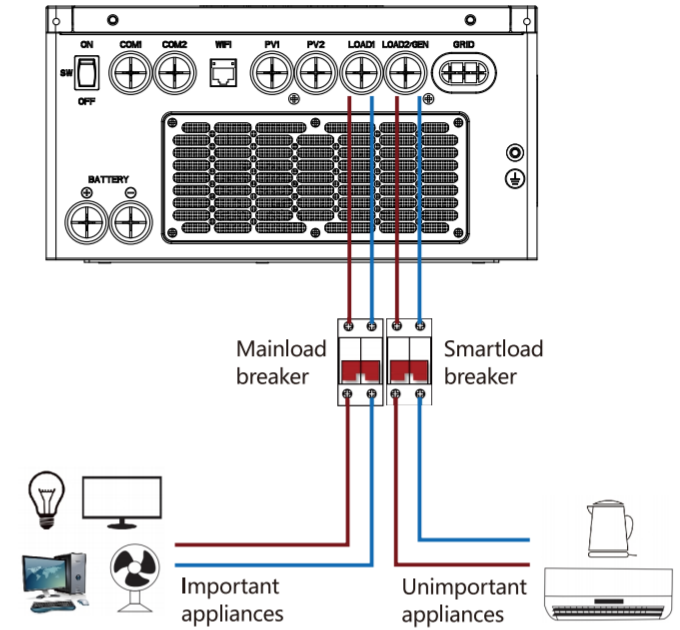

**NOTE:** The dual output port "LOAD-2" for the unimportant appliances. Its function can be set by Setting Page in program 60 to 66.

## OPERATION

### Power ON/OFF

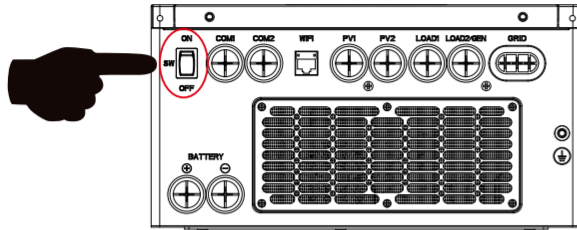

Once the unit has been properly installed and the batteries are connected well, simply press on/off switch (located on the bottom of the case) to turn on/off the unit.

### Operation and Display Panel

The operation and display panel, shown in below chart, is on the front panel of the inverter. It includes three indicators, four function keys and a LCD display, indicating the operating status and input/output power information.



Function Key	Icon	Description
ESC		To previous page
UP		To go to previous selection
DOWN		To go to next selection
ENTER		To confirm the selection or go to next page

LED Indicator	Icon	Description
Battery		Charging the battery, the LED light flash. If battery is full, the LED light will always-on. The battery is not charged, the LED light will go out.
Utility		Inverter running in utility mode, the LED will always-on.
Inverter		Inverter running in off-grid mode, the LED light will flash. Inverter is not running in off-grid mode, the LED light will go out.
Fault		If inverter in fault event, the LED light will always-on. If inverter in warning event, the LED light will flash. Inverter work normally, the LED light will go out.

#### Buzzer Information

Buzzer beep	Press any button, the buzzer will last for 0.1s. Hold on the "ENTER" button, the buzzer will last for 3s. If in fault event, the buzzer will keep going. If in warning event, the buzzer will beep discontinuous (Check more information on the chapter of "Warning Code Table" ).
-------------	---

### LCD display Icons

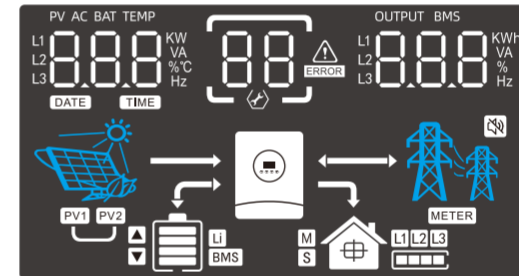

Icon	Function description
<b>Input Source Information</b>	
PV AC BAT TEMP L1 L2 L3 8888 KW VA %C Hz DATE TIME	Indicate input voltage, input frequency, PV voltage, PV power, battery voltage and charger current.
<b>Configuration Program and Fault Information</b>	
	Indicates the setting programs.
	Indicates the warning and fault codes. Warning:  flashing with warning code.
	Fault:  lighting with fault code.

Output Information	
OUTPUT BMS L1 Kwh L2 VA L3 % Hz 8.8.8	Indicate output voltage, output frequency, load percent, load in VA, load in Watt and discharging current.
Battery Information	
	Indicates battery level by 0-24%,25-49%,50-74% and 75-100%. The battery is connected normally, this icon is always on.
	If the inverter is in the process of lithium battery activation, or the battery is not connected, or the inverter is not connected to the grid and the battery voltage is low, this icon will flash.
	Indicates Lithium battery type.
	<b>BMS</b> Indicates communication is built between inverter and BMS. Indicates BMS allows battery discharge. Indicates BMS allows battery charge. Force charge occurs if icon flash.
Mode Operation Information	
	Indicates load is supplied by utility directly.
	Indicates the utility charger circuit is working.
	Indicates the inverter/charger is working.
	Indicates PV MPPT is working to power load.
	Indicates PV MPPT is working to charge battery.
	Indicates battery is discharging to load.
Mute Operation	
	Indicates unit alarm is disabled.
	The meter indicates that it is on.

### LCD operation flow chart

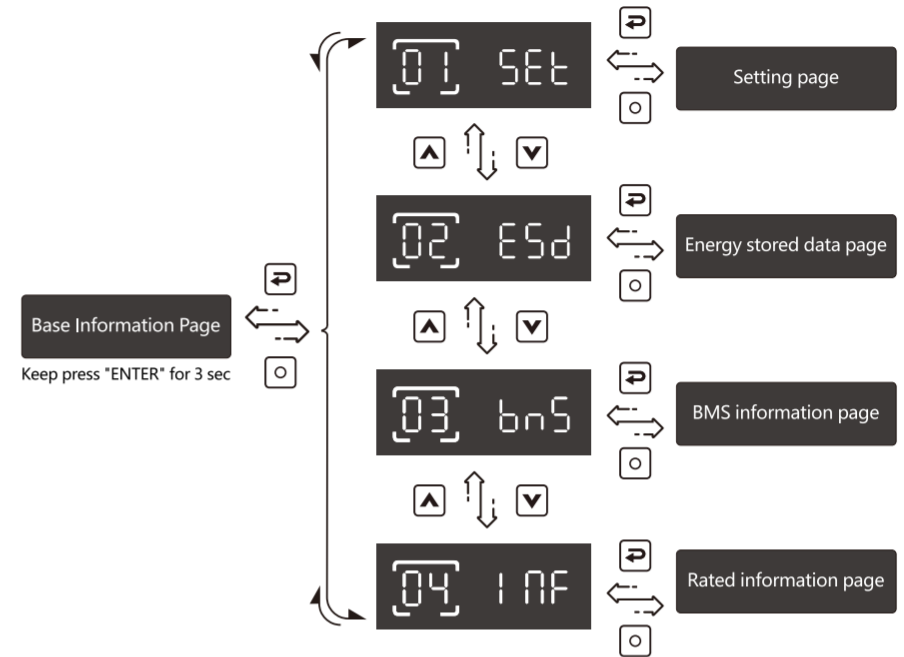

On base information page, pressing and holding "ENTER" key for 3 sec, the unit will enter parameters page. Press "UP" or "DOWN" key to switch the selection and press "ENTER" key to enter selected page. Press "ESC" key to back to previous page.

### Base information Page

1. The base information will be switched by pressing "UP" or "DOWN" key. The selectable information is switched as below order:
2. By default, 1 and 2 are displayed, indicating output from both channels. If the second output is disconnected, only 1 is displayed. If item 64 is set to single output, neither 1 nor 2 is displayed.

<p><b>Default interface</b>                      Left: PV1 power.                      Right: Load power and dual output state (1, 2).</p>	<p>Left: PV1 power.                      Right: PV daily power generation.                      Middle:  indicates that the current page displays PV information.</p>
--	---

Left: PV1 voltage.  
Right: PV1 input current.  
Middle:  $\overline{PV}$  indicates that the current page displays PV information.

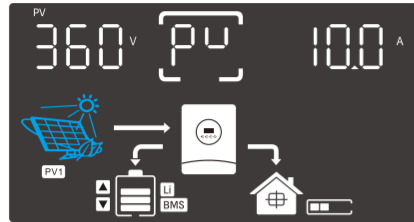

Left: PV2 power.  
Right: PV daily power generation.  
Middle:  $\overline{PV}$  indicates that the current page displays PV information.

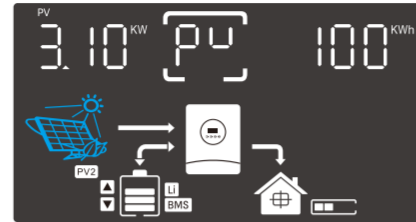

Left: PV2 voltage.  
Right: PV2 input current.  
Middle:  $\overline{PV}$  indicates that the current page displays PV information.

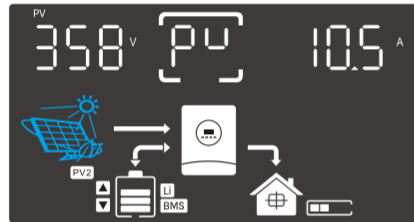

Left: Grid power, use electricity is "+", feed to grid is "-".  
Right: Grid daily consume power.  
Middle:  $\overline{AC}$  Indicates that the current page displays grid information.

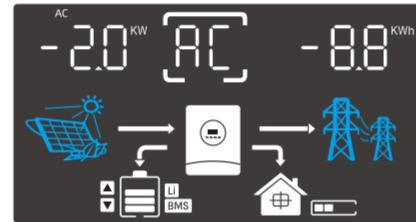

Left: Grid voltage.  
Right: Grid power, use electricity is "+", feed to grid is "-".  
Middle:  $\overline{AC}$  Indicates that the current page displays grid information.

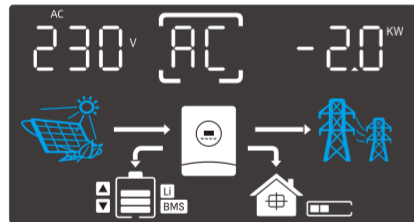

Left: Grid frequency.  
Right: Grid current.  
Middle:  $\overline{AC}$  Indicates that the current page displays grid information.

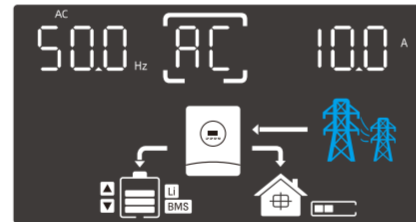

Left: Battery power(charging is "+"; discharging is "-").  
Right: Battery SOC (displaying the battery voltage when without BMS).  
Middle:  $\overline{BA}$  Indicates that the current page displays battery information.

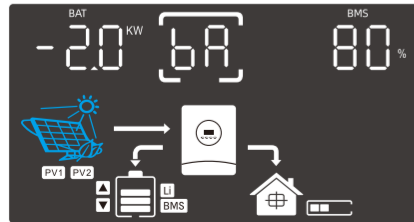

Left: Battery voltage.  
Right: Battery charge-discharge current(charge-discharge to display by means of the energy direction).  
Middle:  $\overline{BA}$  Indicates that the current page displays battery information.

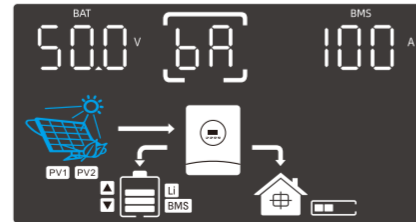

Left: Output load power in VA.  
Right: Output load power in Watt.  
Middle:  $\overline{LD}$  Indicates that the current page displays output load information.

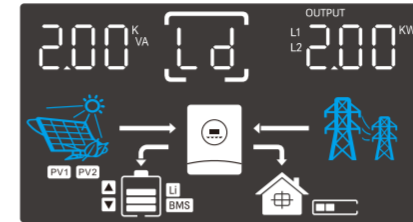

Left: Output frequency.  
Right: Output voltage.  
Middle:  $\overline{LD}$  Indicates that the current page displays output load information.

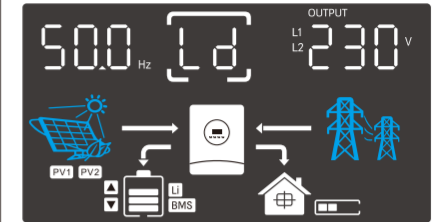

Left: Output current.  
Right: Percentage of output power.  
Middle:  $\overline{LD}$  Indicates that the current page displays output load information.

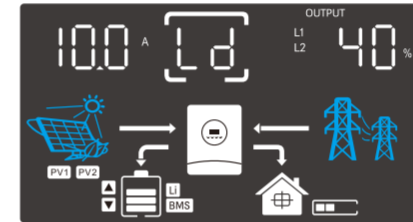

Date  
2023-06-01

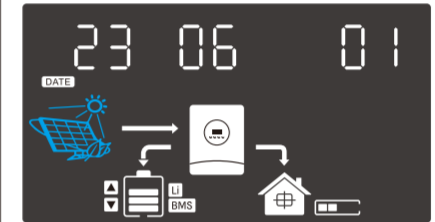

Time  
10:30:25

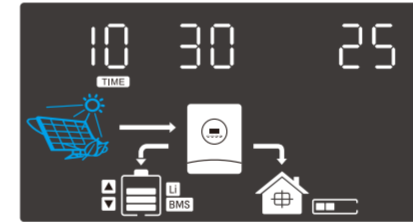

## Setting Page

Press "UP" or "DOWN" button to select setting programs. And then, press "ENTER" button to confirm the selection or ESC button to exit. Keep pressing UP or DOWN button after 1.5 seconds, it will increase or decrease setting value quickly.

### Setting items

		Selectable option		
00	Exit setting		ESC	
01	Battery type setting	Default bAt	AGM	If "User-Defined" or "Lib" is selected, battery charge voltage and low DC cut-off voltage can be set up in program 03, 04 and 05. If "Lib" is selected, inverter can charge lithium battery when the lithium battery need to be activated. Please make sure lithium battery is connected before you start up inverter. If inverter doesn't connect battery or lithium battery, do not select "Lib" battery type.
		Flooded bAt	FLD	
		self-defined bAt	USE	
		Lib bAt	LIB	
02	BMS type	Default bns	1	Default Protocol. (BMS-485)
		BMS bns	0	Protocol 0. (BMS-485)
		BMS bns	20	Protocol 20. (BMS-CAN)
		BMS bns	21	Protocol 21. (BMS-CAN)
03	Bulk charging voltage setting (CV voltage)	Default CV	48V model 56.4 <sup>v</sup>	If "self-defined" or "Lib" is selected in program 01, this program is enabled. Setting range is from 48.0V to 60.0V.
04	Floating charging voltage	Default FLV	48V model 54.0 <sup>v</sup>	If "self-defined" or "Lib" is selected in program 01, this program is enabled. Setting range is from 48.0V to 60.0V.
05	Low DC cut-off voltage or SOC	When only powered by battery, if the battery voltage /SOC is lower than the set value of program 05, the inverter will shut down.		
		Default bCV	48V model 42.0 <sup>v</sup>	If "self-defined" or "Lib" is selected in program 01, this program is enabled. Setting range is from 42.0V to 48.0V.

		Default bCV	10%	If the battery type is lithium battery, the set value will change to SOC. Setting range is from 0% to 90%.
06	Setting battery voltage or SOC point back to utility when selecting "SBU priority" in program 24	Default bUV	48V model 46.0 <sup>v</sup>	Setting range is from 44.0V to 54.0V. Increment of each click is 0.1V.
		Default bUV	20%	If the battery type is lithium battery, the set value will change to SOC. Setting range is from 5% to 90%.
07	Setting battery voltage point back to battery mode when selecting "SBU priority" in program 24	Default bBV	48V model 54.0 <sup>v</sup>	Setting range is from 48.0V to 60.0V. Increment of each click is 0.1V.
		Fully charged bBV	FUL	Battery should be charged to float charging stage.
		Default bBV	70%	If the battery type is lithium battery, the set value will change to SOC. Setting range is from 10% to 100%.
09	Max charging current (Utility charge current +PV charging current)	Default bCC	60A 60 <sup>A</sup>	Setting range is from 5A to 120A. Increment of each click is 1A.
10	Max utility charging current setting	Default CHC	60A 60 <sup>A</sup>	Setting range is from 5A to 120A. Increment of each click is 1A.
20	AC output mode	Default PAL	Single S1C	When the units are used in parallel with single phase, please select "PAL" in program 20. It's required to have at least three inverters to support three-phase equipment. It's required to have at least one inverter in each phase or it's up to ten inverters in one phase. Please select "3P1" in program 20 for the inverters connected to L1 phase, "3P2" in program 20 for the inverters connected to L2 phase and "3P3" in program 20 for the inverters connected to L3 phase. Before starting up inverters, please connect all N wires of AC output together.
		PAL	Parallel PAL	
		PAL	L1 Phase 3P1	
		PAL	L2 Phase 3P2	
		PAL	L3 Phase 3P3	
21	Output voltage setting	Default OPV	230V 230 <sup>v</sup>	Output voltage configuration.













NOTE: The setting value of item "07" should be larger than the setting value of item "06".

		220V OPV  220	
		240V OPV  240	
22	Output frequency setting	Default 50Hz OPF  50	Output frequency configuration.
		60Hz OPF  60	
23	Utility input range setting	Default Appliance mode AC  APL	Mains operating range: APL: 90-280V; UPS: 170-280V. The APL mode is suitable for ordinary household electrical loads. UPS mode is suitable for computer loads. When the effect is not satisfactory, it is recommended to adjust to APL.
		UPS mode AC  UPS	
24	Output source priority	Default PV >> Utility >> Battery OPS  SUB	PV provides power to the loads first. If PV is not sufficient, utility will supply power to the loads at the same time. Battery will provide power to loads only when utility is not available.
		Utility >> PV >> Battery OPS  SUB	Utility provides power to the loads first. PV and battery will provide power to loads only when utility is not available.
		PV >> Battery >> Utility OPS  SUB	PV provides power to the loads first. If PV is not sufficient, battery will supply power to the loads at the same time. Utility provides power to the loads only when battery voltage drops to the setting point in program 6.
		Intelligent output source priority OPS  INT	The intelligent priority can use more solar energy and save electricity bills. It is applicable to South Asia (such as Pakistan) and Africa. In this priority mode, the PV provides power to the loads first. If PV is not sufficient, battery or utility will supply power to the loads at the same time. If the energy storage system is not installed with solar panels, do not choose this priority mode.
25	Charger priority	If inverter is working in utility mode, charger priority can be set as below. However, when inverter is working in battery mode, only PV can charge battery.	
		Default PV First CHS  CSO	PV will charge battery first. Utility will charge battery only when PV is unavailable.
		PV and Utility CHS  SNU	PV and utility will charge battery together.

		PV Only CHS  CSO	Only PV can charge the battery.
26	Feeding power to grid	Default Disable FPG  DIS	If selected, inverter is not allowed to feed exceeding solar power to grid.
		Enable FPG  ENA	If selected, inverter is allowed to feed exceeding solar power to grid.
27	Overload bypass function	Default Enable LBP  ENA	If it is enabled, the inverter will switch to utility mode if overload happens in battery mode. The value is valid in SBU /INT mode.
		Disable LBP  DIS	
28	Overload restart function	Default Enable OLT  ENA	If it is enabled, the inverter will auto restart when overload occurs.
		Disable OLT  DIS	
29	Over temperature restart function	Default Enable OET  ENA	If it is enabled, the inverter will auto restart when over temperature occurs.
		Disable OET  DIS	
30	Power -Voltage curve	Default Enable PU  ENA	It is used to adjust the inverter active power according to the grid voltage. When the grid voltage exceeds 250V, the inverter begins to reduce active power.
		Disable PU  DIS	
31	Zero Export Power	Default 0 ZEP  0	Regulate the input power of the Grid while in SBU Mode. Setting range is from -90W to 90W. Increment of each click is 10W.
32	PE-N Relay	Default Disable PEN  DIS	Please select whether to enable this function based on local grid regulations: When set to DISABLE (default), the N wire port and the ground wire port are disconnected inside the inverter. When set to ENABLE, the N wire port and the ground wire port are connected inside the inverter.
		Enable PEN  ENA	







40	Backlight of LCD	Default bL 40	Enable ENR	If selected, LCD backlight will be always-on.
		bL 40	Disable DIS	If selected, LCD backlight will be off after no button is pressed for 60s.
41	Auto return to the first page of display screen	Default bFP 41	Disable DIS	If selected, the display screen will stay at the last screen displayed.
		bFP 41	Enable ENR	If selected, it will automatically return to the first page of display screen (Input voltage / output voltage) after no button is pressed for 60s.
42	Buzzer alarm	Default bEP 42	Enable ENR	If selected, buzzer is allowed to beep.
		bEP 42	Disable DIS	If selected, buzzer is not allowed to beep.
44	Reset default	Default FSt 44	DIS	If selected, default initial settings page.
		FSt 44	ENR	If selected, Enable restores all settings other than the parallel. Output mode setting item (20) to their initial values.
45	Fan work mode	Default FAN 45	PFC	In performance mode, the inverter will perform at it's highest performance.
		FAN 45	BLC	Balanced mode, applicable to the condition of 75% output power and 90A charge current limitation, to reduce additional noise greatly.
		FAN 45	SLC	Silent mode, applicable to the condition of 50% output power and 60A charge current limitation, to reduce additional noise effectively.
46	Failure recovery	Default FtS 46	Disable DIS	If selected, when the inverter enter the fault state, the inverter will not exit the fault state or start up again.
		FtS 46	Enable ENR	If selected, when the inverter enter the fault state, the inverter will exit the fault state and start up again.
50	Time setting-Year	Year YER 50	23	Setting range is from 23 to 99.

51	Time setting-Month	Month n0N 51	8	Setting range is from 1 to 12.
52	Time setting-Day	Day dAY 52	20	Setting range is from 1 to 31.
53	Time setting-Hour	Hour HOu 53	21	Setting range is from 0 to 23.
54	Time setting-Minute	Minute n 1n 54	43	Setting range is from 0 to 59.
55	Time setting-Second	Second SEc 55	50	Setting range is from 0 to 59.
60	Low DC cut off voltage on second output	Default bCS 60	48V model 420V	Setting range is from 42.0V to 48.0V. Increment of each click is 0.1V. This low DC cut-off voltage will be fixed to setting value no matter what percentage of load is connected.
		Default bCS 60	10%	If any type of lithium battery is selected in program 1, this parameter value will be displayed in percentage and value setting is based on battery capacity percentage. Setting range is from 0% to 95%. Increment of each click is 1%.
62	Scheduled time for 2nd AC output on	Default tD0 62	0	Setting range is from 00:00 to 23:00. Increment of each click is 1 hour.
63	Scheduled time for 2nd AC output off	Default tDF 63	0	Within scheduled on/off time setting in program 62 and 63, 2nd AC output will be turn on/off.
64	Dual output Settings	Default SPt 64	Enable AUT	<ol style="list-style-type: none"> <li>The second output is normally on: The grid is power on.</li> <li>The second output is turned off: The grid is power off and the battery voltage or SOC is less than program 60.</li> <li>The second output is recovery: The grid is power off and the battery voltage &gt; program 07 setting voltage, or the SOC &gt; program 07 setting SOC.</li> </ol> <p><b>NOTE:</b> Only generator function is disable, the second output can be setting successfully.</p>

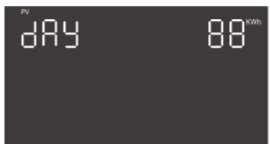
		SPE  E1 n	2nd AC output will be turn on/off according to setting in program 62 and 63.
		SPE  Disable dis	Disabled, single output only.
65	Generator power limit	Default GNP  12 <sup>kw</sup>	Generator input power limit, set range from 1kW to 11.5kW, increase by 1kW per click. <b>Note:</b> 1. The set value must not exceed the generator's rated power to prevent device damage; 2. This function becomes ineffective when load power exceeds the set value (input power will match load demand); 3. The set value allocates power flexibly: e.g., if set higher than the load, surplus power will automatically charge the battery. 4. The maximum port current is 40A.
66	Generator function setting	Default GEN  Disable dis	If selected, Generator function is disable, the dual output function is enable according to the program 64.
		Enable GEN  ENA	If selected, Generator function is enable, the dual output function is disable in the program 64.
67	Scheduled time for AC charge on	Default ACO  0	Setting range is from 0~23 hour. If the time achieves the setting vaule, AC charge will be allowed/not allowed.
68	Scheduled time for AC charge off	Default ACF  0	If the setting time for AC charge on and off are the same, the AC charge will be allowed always.
80	Zero Export Mode	Default Lod  0	If "Meter" is selectes, Meter Protocol can set up in program 81. <b>NOTE:</b> The inverter must be connected to CT or meter to enable anti-reflux function. Otherwise, the feed power cannot be controlled. (Only CT with a ratio of 1:1000 is supported)
		CT ct  1	
		Meter nnt  2	
81	Meter Protocol	Default nnp  1	Default Protocol.
		Meter Protocol nnp  100	Protocol 0.

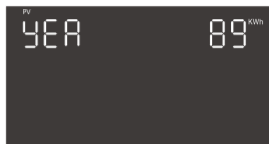
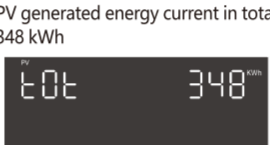

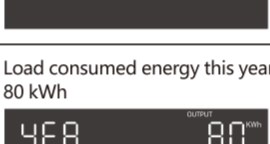
### Energy stored data Page

The energy stored data will be switched by pressing "UP" or "DOWN" key. The selectable information is switched as below order:

PV generated energy today 88 kWh 	PV generated energy this month 88 kWh 	PV generated energy this year 89 kWh 
PV generated energy current in total 348 kWh 	Load consumed energy today 78 kWh 	Load consumed energy this month 78 kWh 
Load consumed energy this year 80 kWh 	Load consumed energy in total 272 kWh 	

### BMS information Page

The BMS information will be switched by pressing "UP" or "DOWN" key. The selectable information is switched as below order:

Battery pack number / mean SOC Connected battery pack number is 4, mean SOC is 97% 	
BMS voltage /SOC BMS voltage is 54.0V, SOC is 99% on battery pack of address 1 	BMS voltage / current BMS voltage is 54.0V, current is 5A on battery pack of address 1 

BMS highest temperature / lowest temperature  
BMS highest temperature is 25°C, lowest temperature is 20°C on battery pack of address 1



BMS fault code / flag  
BMS fault code is 0, flag is 000 on battery pack of address 1



### Rated information Page

The rated information will be switched by pressing "Up" or "DOWN" key. The selectable information is switched as below order:

Rated VA / WATT  
Rated VA is 6kVA, WATT is 6kW



Rated battery voltage / Max. charge current  
Rated battery voltage is 48V, Max. charge current is 120A



Firmware version  
Firmware version is 1400

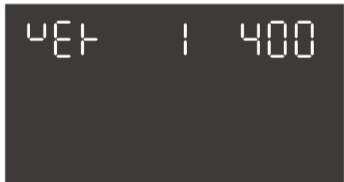

### Lithium Battery Communication

It's allowed to connect lithium battery and build communication only which it has been configured. Please follow below steps to configure communication between lithium battery and inverter.

1. Connect power cable between lithium battery and inverter. Please pay attention to the terminals of positive and negative. Make sure the positive terminal of battery is connected to the positive terminal of inverter, and the negative terminal of battery is connected to the negative terminal of inverter.
2. The communication cable is bundled with lithium battery. Both sides are RJ45 port. One port is connected to the BMS port of inverter and the other one is connected to the COMM port of lithium battery.

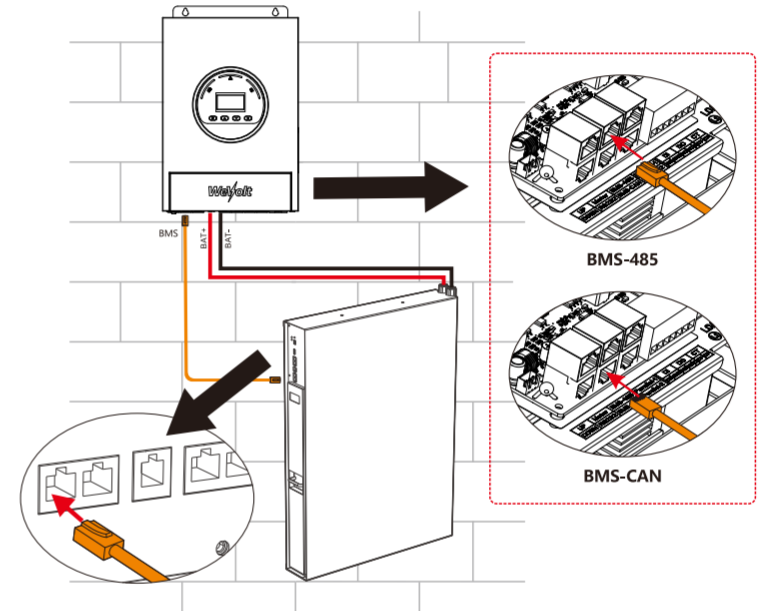

3. Configure battery type to "Lib" in LCD setting No.01.

The battery type is Lib

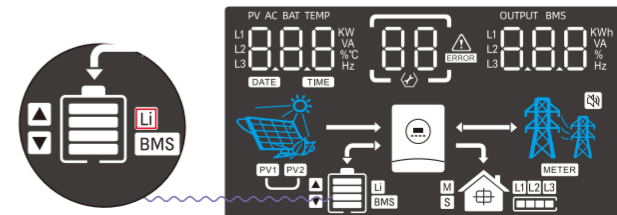

4. Power up lithium battery and inverter. Wait a moment, if the communication is built between them, LCD will show you "BMS" icon as below.

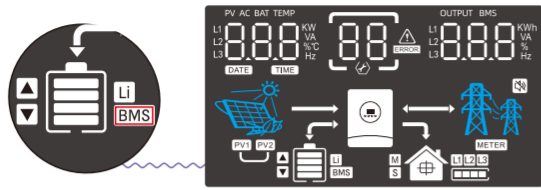

5. Roll LCD real time information pages by pressing "UP" or "DOWN" button, as below page, you can see the parameters of SOC in the communication system.

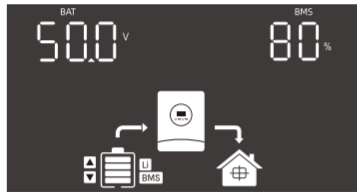

This page means SOC is 80%.

## PARALLEL INSTALLATION GUIDE

### Introduction

This inverter can be used in parallel with two different operation modes.

1. Parallel operation in single phase with up to 12 units, the supported maximum output power is 72kW/72kVA.
2. Maximum twelve units work together to support three-phase equipment, with at least 1 unit per phase. The supported maximum output power is 72kW/72kVA and one phase can be up to 72kW/72kVA.

**NOTE 1:** If this unit is bundled with share current cable and parallel cable, this inverter is default supported parallel operation. You may skip section 2.

**NOTE 2:** Under parallel operation modes, battery must be connected with inverters.

**NOTE 3:** Before starting up inverters, please connect all positive (+) and negative (-) wires of battery together.

### Mounting the Unit

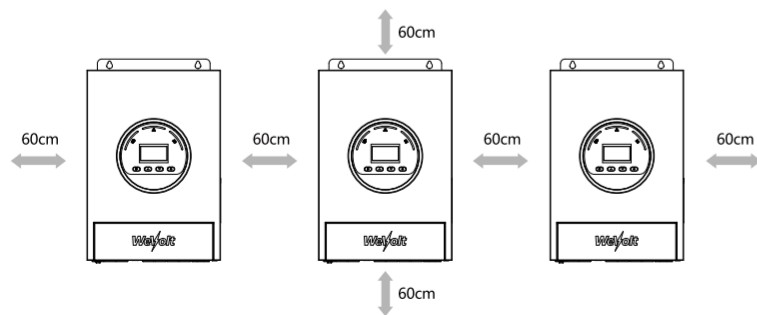

**NOTE:** For proper air circulation to dissipate heat, allow a clearance of approx 60cm to the side and approx 60cm above and below the unit. Be sure to install each unit in the same level.

## Package Contents

In parallel kit, you will find the following items in the package:



Parallel communication cable x 1pcs



Parallel communication terminal connector x1pcs

## Wiring Connection

Inverters Communication Connection

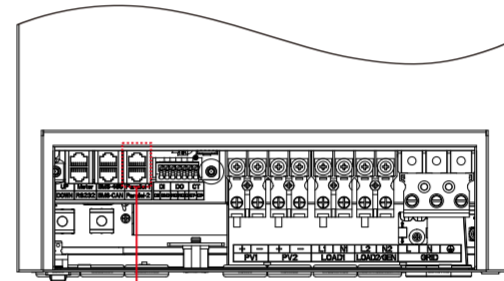

Connect parallel communication connector to the first one and the last one.

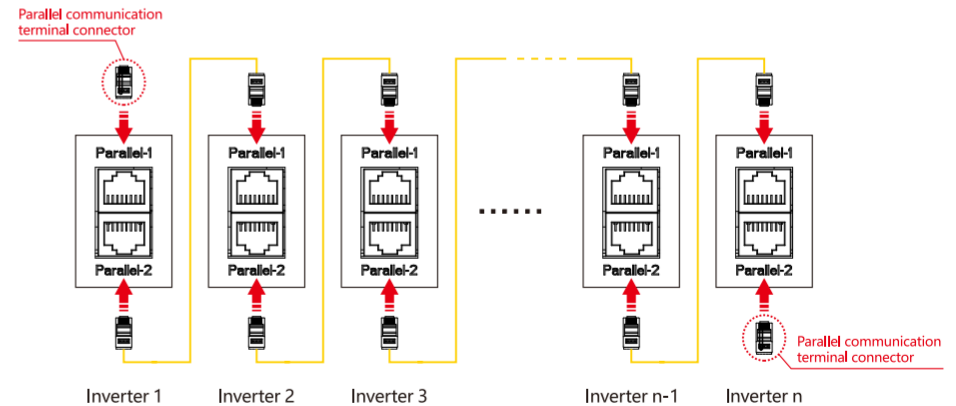

Connect parallel communication cable one by one.

Single Phase Parallel connection diagram for two inverters in parallel for WWLVS-IP55-6KW.

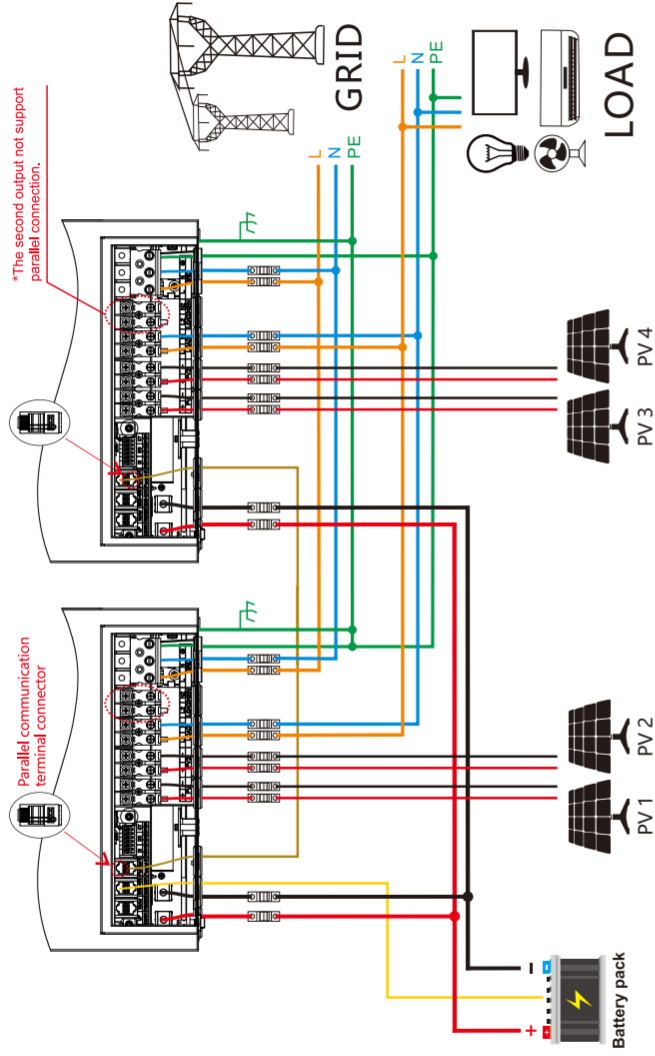

**⚠ WARNING!** Strictly maintain insulation between PV ports in parallel systems. A single PV module's L/N lines **MUST NOT** be connected to PV ports of two or more inverters in the parallel configuration.

**NOTE:** Before starting up inverters, please connect all positive (+) and negative (-) wires of battery together.

Single Phase Parallel connection diagram for 3-12 inverters in parallel for WWLVS-IP55-6KW.

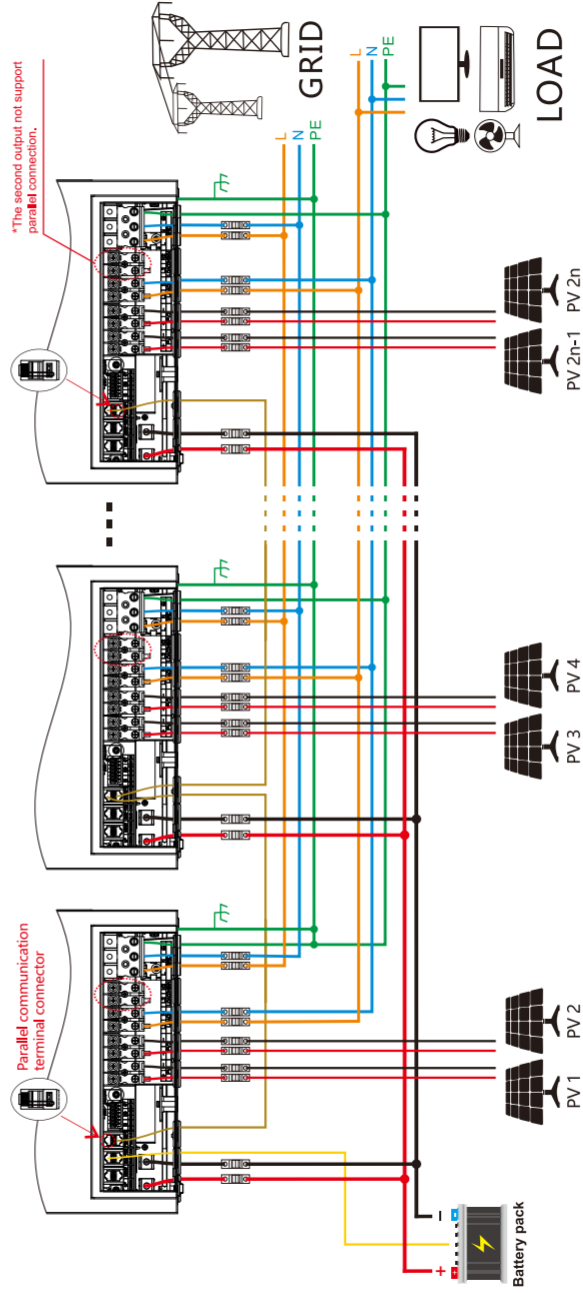

**⚠ WARNING!** Strictly maintain insulation between PV ports in parallel systems. A single PV module's L/N lines **MUST NOT** be connected to PV ports of two or more inverters in the parallel configuration.

**NOTE:**

1. "n" is the number of parallel connections of the inverters.
2. Before starting up inverters, please connect all positive (+) and negative (-) wires of battery together.

Three Phase Parallel connection diagram for three inverters in parallel for WWLVS-IP55-6KW.

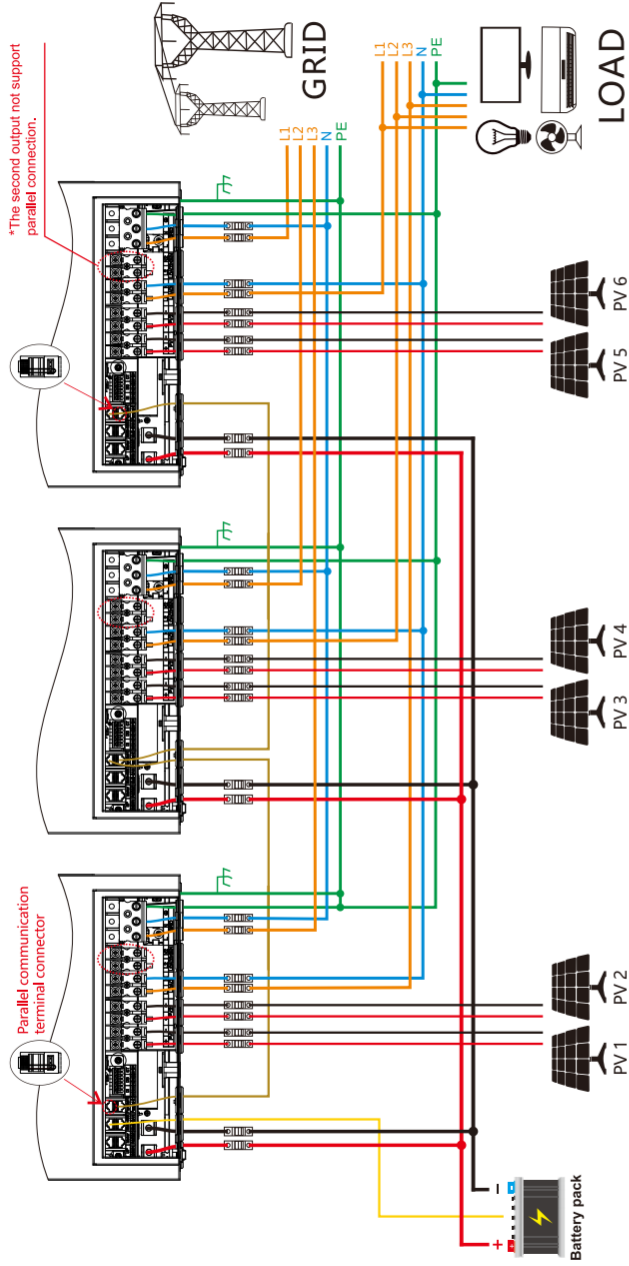

**WARNING!!** Strictly maintain insulation between PV ports in parallel systems. A single PV module's L/N lines **MUST NOT** be connected to PV ports of two or more inverters in the parallel configuration.

**NOTE:** Before starting up inverters, please connect all positive (+) and negative (-) wires of battery together.

Three Phase Parallel connection diagram for 4-12 inverters in parallel for WWLVS-IP55-6KW.

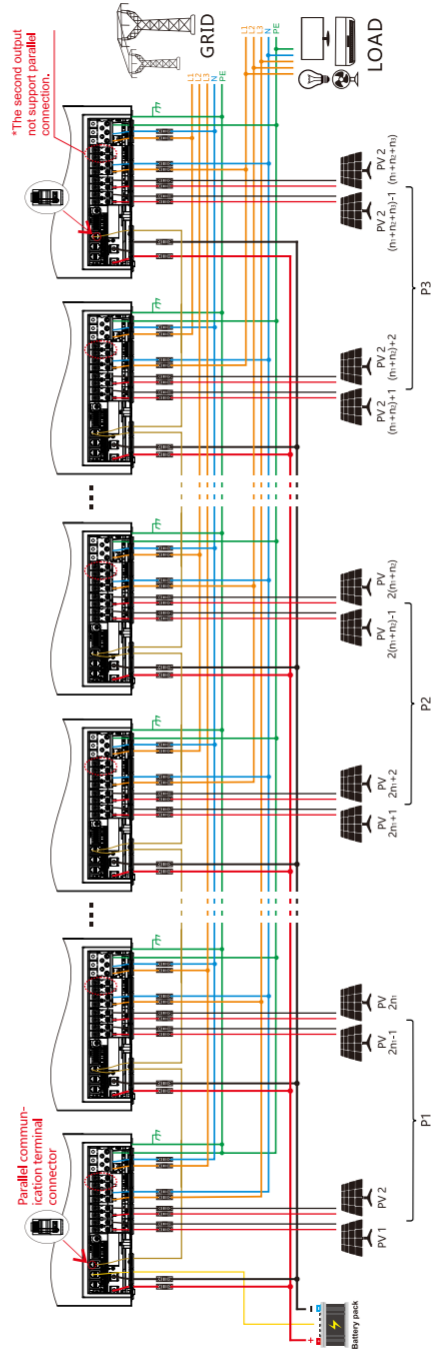





**WARNING!!** Strictly maintain insulation between PV ports in parallel systems. A single PV module's L/N lines **MUST NOT** be connected to PV ports of two or more inverters in the parallel configuration.

**NOTE:**

1. "n1" / "n2" / "n3" is the number of parallel units for P1/P2/P3 phase.
2. Before starting up inverters, please connect all positive (+) and negative (-) wires of battery together.
3. Each phase is connected with at least one, a maximum of 6 parallel units for same phase, and a maximum of 12 parallel units for three phases.

## LCD Setting and Display

## Setting Program

20	AC output mode	Single 	When the units are used in parallel with single phase, please select "PAL" in program 20. It is required to have at least three inverters or maximum twelve inverters to support three-phase equipment.  It's required to have at least one inverter in each phase or it's up to ten inverters in one phase.  Please select "3P1" in program 20 for the inverters connected to L1 phase, "3P2" in program 20 for the inverters connected to L2 phase and "3P3" in program 20 for the inverters connected to L3 phase.  Before starting up inverters, please connect all N wires of AC output together.
		Parallel 	
		L1 Phase 	
		L2 Phase 	
		L3 Phase 	

## Commissioning

## Parallel in single phase

Step 1: Check the following requirements before commissioning:

- Correct wire connection.
- Ensure all breakers in Line wires of load side are open and each Neutral wires of each unit are connected together.

Step 2: Turn on each unit and set "PAL" in LCD setting program 20 of each unit. And then shut down all units.

**NOTE:** To be safe, it's better to turn off switch when setting LCD program.

Step 3: Turn on each unit.

**NOTE:** Master and slave units are randomly defined.

Step 4: Switch on all AC breakers of Line wires in AC input. It's better to have all inverters connect to utility at the same time. However, these inverters will automatically restart. If detecting AC connection, they will work normally.

Step 5: If there is no more fault alarm, the parallel system is completely installed.

Step 6: Please switch on all breakers of Line wires in load side. This system will start to provide power to the load.

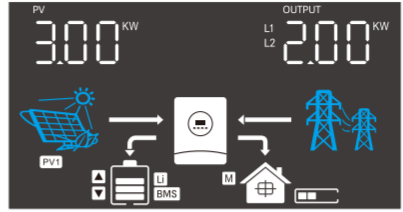
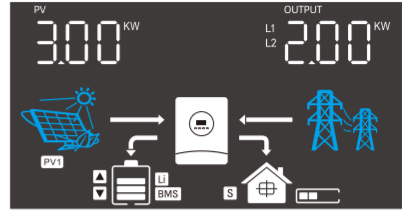
LCD display in Master unit	LCD display in Slave unit
	

## Support three-phase equipment

Step 1: Check the following requirements before commissioning:

- Correct wire connection.
- Ensure all breakers in Line wires of load side are open and each Neutral wires of each unit are connected together.

Step 2: Turn on all units and configure LCD program 20 as P1, P2 and P3 sequentially. And then shut down all units.

**NOTE:** To be safe, it's better to turn off switch when setting LCD program.

Step 3: Turn on all units sequentially.

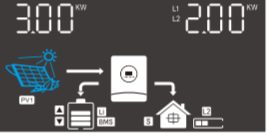
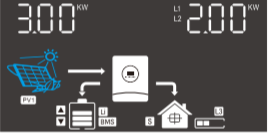
LCD display in L1-phase unit	LCD display in L2-phase unit	LCD display in L3-phase unit
		

Step 4: Switch on all AC breakers of Line wires in AC input. If AC connection is detected and three phases are matched with unit setting, they will work normally. Otherwise, the AC icon  will flash and they will not work in line mode.

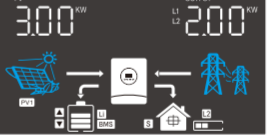
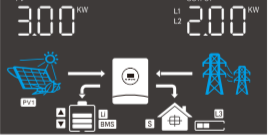
LCD display in L1-phase unit	LCD display in L2-phase unit	LCD display in L3-phase unit
		

Step 5: If there is no more fault alarm, the system to support 3-phase equipment is completely installed.

Step 6: Please switch on all breakers of Line wires in load side. This system will start to provide power to the load.

**NOTE 1:** To avoid overload occurring, before turning on breakers in load side, it's better to have whole system in operation first.

**NOTE 2:** Transfer time for this operation exists. Power interruption may happen to critical devices, which cannot bear transfer time.

## WARNING CODE TABLE

When fault event happens, the fault LED is flashing. At the same time, warning code, icon  is shown on the LCD screen.

Warning Code	Warning Information	Audible Alarm	Trouble shooting
01	Overload	Beep twice every second	Reduce the loads.
02	Fan is locked (circulation fan)	Beep three time every second	Check if the Fans wiring connected well. Replace the fan.
03	Fan is locked (centrifugal fan)	Beep three times every second	Check if the Fans wiring connected well. Replace the fan.
04	Grid over voltage warning	No buzzer alarm	Check whether the grid voltage exceeds the allowable range of the inverter.
05	Output not connected together in parallel mode	No buzzer alarm	Check whether the output load of the inverter is normal, and check whether the inverters are connected together in the same phase.
06	Remote shutdown warning	No buzzer alarm	Check if remote shutdown is enabled via WIFI. Disable the enable or restart the inverter.
07	Second output overload	No buzzer alarm	Reduce the connected load by switching off some equipment, and restart the unit, if the error happens again, please return to repair center.
08	BMS communication failure	No buzzer alarm	Check whether the inverter 01 setting items selected for LI battery. If item 01 is set to lithium battery mode, check whether the communication line between the battery pack and the inverter is properly connected.
10	Parallel grid lost	No buzzer alarm	Check whether the mains input cable of the inverter is abnormal, and restart the unit, if the error happens again, please return to repair center.
11	Abnormal battery voltage	No buzzer alarm	Check whether the battery has any abnormal faults or if the battery power is insufficient to support the current load. If the battery power is insufficient, please reduce the load usage. If there is any abnormality with the battery, please contact the repair center to troubleshoot the issue.

## FAULT CODE TABLE

When fault event happens, inverter will cut off output, and the fault LED is solid on. At the same time, fault code, icon  and **ERROR** are shown on the LCD screen.

Fault Code	Fault information	Trouble Shooting
01	Bus voltage is too high	AC Surge or internal components failed. Restart the unit, if the error happens again, please return to repair center.
02	Bus voltage is too low	Restart the unit, if the error happens again, please return to repair center.
03	Bus soft start fail	Internal components failed. Restart the unit, if the error happens again, please return to repair center.
10	Inverter soft start fail	Internal components failed. Restart the unit, if the error happens again, please return to repair center.
11	Over current or surge detected by Software	Restart the unit, if the error happens again, please return to repair center.
12	Over current or surge detected by hardware	Restart the unit, if the error happens again, please return to repair center.
13	Output voltage is too low	Reduce the connected load. Restart the unit, if the error happens again, please return to repair center.
14	Output voltage is too high	Restart the unit, if the error happens again, please return to repair center.
15	Output short circuited	Check if wiring is connected well and remove abnormal load.
16	Inverter current sensor failed	Restart the unit, if the error happens again, please return to repair center.
17	Current feedback into the inverter is detected.	1. Restart the inverter. 2. Check if L/N cables are not connected reversely in all inverters. 3. For parallel system in single phase, make sure the sharing cables are connected in all inverters. For supporting three-phase system, make sure the sharing cables are connected in the inverters in the same phase, and disconnected in the inverters in different phases. 4. If the problem remains, please contact your installer.
20	Overload time out	Reduce the connected load by switching off some equipment.
21	OP current sensor failed	Restart the unit, if the error happens again, please return to repair center.
22	Sharing current sensor failed	Restart the unit, if the error happens again, please return to repair center.
23	The AC input and output wire sare inversely connected	1. Please check AC input and output wires are connected correctly. 2. If this error happens during parallel installation, please check wires connection. If they are connected correctly, please finish parallel installation first, and then restart inverters. 3. If the problem remains, please contact your installer.
24	The output relay exception	Restart the unit, if the error happens again, please return to repair center.
30	Battery voltage is too high	Check if spec and quantity of batteries are meet requirements.

31	Over current happen at DC/DC circuit	Restart the unit, if the error happens again, please return to repair center.
32	DC/DC current sensor failed	Restart the unit, if the error happens again, please return to repair center.
33	No.2 DCDC current sensor failed	Restart the unit, if the error happens again, please return to repair center.
34	DC/DC soft start fail	Restart the unit, if the error happens again, please return to repair center.
35	Over current happen at DC/DC circuit detected by hardware	Restart the unit, if the error happens again, please return to repair center.
36	Over current happen at LLC circuit	Restart the unit, if the error happens again, please return to repair center.
37	LLC hardware fault	Restart the unit, if the error happens again, please return to repair center.
40	PV voltage is too high	Reduce the number of PV modules in series.
41	Short circuit detected at PV port	Check if wiring is connected well.
42	PV power anomaly	Restart the unit, if the error happens again, please return to repair center.
43	Over current happen at PV port	Restart the unit, if the error happens again, please return to repair center.
44	PV current sensor failed	Restart the unit, if the error happens again, please return to repair center.
45	PV1 high input power	Reduce the connected load. Restart the unit, if the error happens again, please return to repair center.
46	PV2 high input power	Reduce the connected load. Restart the unit, if the error happens again, please return to repair center.
50	Fan is locked	Check if wiring is connected well. Replace the fan.
51	Over temperature happen at PV circuit	The temperature of internal PV component is over the limitation. Check whether the air flow of the unit is blocked or whether the ambient temperature is too high.
52	Over temperature happen at INV circuit	The temperature of internal INV component is over the limitation. Check whether the air flow of the unit is blocked or whether the ambient temperature is too high.
53	Over temperature happen at Convert L circuit	The temperature of Convert L battery converter component is over the limitation. Check whether the air flow of the unit is blocked or whether the ambient temperature is too high.
54	Over temperature happen at Convert H circuit	The temperature of internal Convert H component is over the limitation. Check whether the air flow of the unit is blocked or whether the ambient temperature is too high.
55	Over temperature happen at LLC TX	The temperature of internal DC/DC TX is over the limitation. Check whether the air flow of the unit is blocked or whether the ambient temperature is too high.

60	CAN data loss	1. Check if communication cables are connected well and restart the inverter. 2. If the problem remains, please contact your installer.
61	Host data loss	
62	Synchronization data loss	
63	The firmware version of each inverter is not the same	1. Update all inverter firmware to the same version. 2. Check the version of each inverter via LCD setting and make sure the CPU versions are same. If not, please contact your installer to provide the firmware to update. 3. After updating, if the problem still remains, please contact your installer.
64	The output current of each inverter is different	1. Check if sharing cables are connected well and restart the inverter. 2. If the problem remains, please contact your installer.
65	AC output mode setting is different	1. Switch off the inverter and check LCD setting program 20. 2. For parallel system in single phase, make sure no 3P1, 3P2 or 3P3 is set on program 20. For supporting three-phase system, make sure no "PAL" is set on program 20. 3. If the problem remains, please contact your installer.
66	Single unit is installed to parallel system	1. Please check if single unit is installed to parallel system. 2. If this error happens during parallel installation, please check wires connection. If they are connected correctly, please finish parallel installation first, and then restart inverters. 3. If the problem remains, please contact your installer.
92	DSP failed to communicate with MCU	Restart the unit, if the error happens again, please return to repair center.